

Thule Force 3

Roof box for roof-mounted racks
645XXX

- EN** Roof box for roof-mounted racks
FR Coffre pour barres de toit
ES Cofre portaequipajes para barras de techo
DE Dachbox für Dachträger
NL Dakkoffer
PT Caixa bagageira para barras de tejadilho
IT Box da tetto per portapacchi da installare sul tetto
SV Takbox för takmonterade räckor
DK Tagboks til tagbøjler
NO Takboks til takmonterte stativer
FI Katolle asennettaviin telineisiin sopiva kuljetuslaatikko
IS Pakbox fyrir grindur á þak
ET Katusele paigaldatav katuseboks
LV Jumta kaste uz jumta uzstādāmiem bagāžniekiem
LT Ant stogo tvirtinamų skersinių bagažinės
UK Вантажний бокс для багажників для даху
PL Box dachowy na bagażnik montowany na dachu
CS Střešní box pro montáž na střechech
HU Tetőre szerelhető tetőbox
RO Portbagaj de acoperiș pentru cadru de bare montate pe acoperiș
- SK** Strešný box na strešné nosiče
SL Strešni kovček za strešne prtljajznike
BG Кутия за багаж за релси, монтирани върху покрива
HR Krovna kutija za krovne nosače
EL Μπαγκαζιέρα οροφής για μπάρες οροφής
TR Araç üstüne bağlanan raflar için tavan kutusu
MT Kotak bumbung untuk rak yang dipasang pada bumbung
ZH-SC 用于车顶架的车顶箱
ZH-TR 車頂架專用車頂箱
JA ルーフマウント型ラック用ルーフボックス
KO 루프 장착 랙 루프 박스
TH กล่องบนหลังคาสำหรับแร็คหลังคา
MS Kaxxa għal fuq is-saqaf għal xtillieri mmuntati fuq saqaf
- HE** תא חפצים לגג הרכב
AR صندوق سقف للحوامل المثبتة على السقف



IMPORTANT - READ THE INSTRUCTIONS CAREFULLY BEFORE USE AND KEEP FOR FUTURE REFERENCE.

Symbols



WARNING indicates a hazardous situation which, if not avoided, could result in death or serious injury.



CAUTION indicates a hazardous situation which, if not avoided, could result in minor or moderate injury.



MANDATORY ACTION indicates instructions that must be followed to avoid the risk of injury, and damage to the product or other equipment.



NOTICE indicates instructions that must be followed to avoid damage to the product or other equipment.



NOTE indicates additional information that is useful for trouble-free and optimal use of the product.

IMPORTANTE - LEER LAS INSTRUCCIONES CUIDADOSAMENTE ANTES DEL USAR Y CONSERVELAS PARA FUTURA REFERENCIA.

Símbolos



ADVERTENCIA indica una situación de posible peligro que, si no se evita, podrá provocar lesiones graves o incluso la muerte.



ATENCIÓN indica una situación peligrosa que, si no se evita, podrá provocar lesiones leves o moderadas.



ACCIÓN OBLIGATORIA indica instrucciones que deben seguirse para evitar el riesgo de lesiones y daños al producto u otro equipo.



AVISO indica instrucciones que deben seguirse para evitar daños al producto u otro equipo.



NOTA indica información adicional que es útil para un uso óptimo y sin problemas del producto.

IMPORTANT - LISEZ ATTENTIVEMENT LES INSTRUCTIONS AVANT UTILISATION ET CONSERVEZ-LES POUR RÉFÉRENCE FUTURE.

Symboles



AVERTISSEMENT indique une situation potentiellement dangereuse qui, si elle n'est pas évitée, pourrait provoquer des blessures graves, voire mortelles.



ATTENTION indique une situation potentiellement dangereuse susceptible qui, si elle n'est pas évitée, peut entraîner des blessures mineures ou modérées.



ACTION OBLIGATOIRE indique des instructions qui doivent être suivies pour éviter tout risque de blessure et de dommage au produit ou à d'autres équipements.



AVIS indique des instructions qui doivent être suivies pour éviter d'endommager le produit ou d'autres équipements.



REMARQUE indique comment répondre à une situation donnée et vous donnent des conseils sur le fonctionnement des options disponibles.

WICHTIG - LESEN SIE DIESE ANLEITUNG SORGFÄLTIG DURCH UND BEWAHREN SIE SIE ZUM SPÄTEREN NACHSCHLAGEN AUF.

Symbole



WARNING: eine mögliche Gefahrensituation, die, wenn sie nicht vermieden wird, zum Tod oder zu ernsthaften Verletzungen führen kann.



VORSICHT weist auf eine gefährliche Situation hin, die zu geringfügigen oder mäßigen Verletzungen führen kann, wenn sie nicht vermieden wird.



VERPFLICHTENDE AKTION gibt Anweisungen an, die befolgt werden müssen, um Verletzungen und Schäden am Produkt oder anderen Geräten zu vermeiden



HINWEIS weist auf Anweisungen hin, die befolgt werden müssen, um Schäden am Produkt oder anderen Geräten zu vermeiden.



HINWEIS: eine zusätzliche Information, die für eine problemlose und optimale Verwendung des Produkts nützlich ist.

BELANGRIJK - LEES DE INSTRUCTIES ZORGVULDIG DOOR VOOR GEBRUIK EN BEWAAR ZE VOOR TOEKOMSTIG GEBRUIK.

Symbolen



WAARSCHUWING duidt op een gevaarlijke situatie die, indien deze niet wordt vermeden, de dood of ernstig letsel tot gevolg kan hebben.



VOORZICHTIG wijst op een mogelijk gevaar, dat middelzwaar of licht letsel tot gevolg kan hebben indien men niet de passende maatregelen treft.



VERPLICHTE ACTIE geeft instructies aan die moeten worden opgevolgd om letsel en schade aan het product of andere apparatuur te voorkomen



LET OP geeft instructies aan die moeten worden opgevolgd om schade aan het product of andere apparatuur te voorkomen.



OPMERKING geeft aanvullende informatie aan die nuttig is voor een probleemloos en optimaal gebruik van het product.

IMPORTANTE - LER CUIDADOSAMENTE AS INSTRUÇÕES ANTES DE USAR E GUARDÁ-LAS PARA FUTURA REFERÊNCIA.

Símbolos



ATENÇÃO indica uma situação perigosa que, se não for evitada, pode resultar em morte ou ferimentos graves.



CUIDADO indica uma situação perigosa que, se não for evitada, pode resultar em ferimentos ligeiros ou moderados.



AÇÃO OBRIGATÓRIA indica instruções que devem ser seguidas para evitar o risco de lesões e danos ao produto ou a outros equipamentos



AVISO indica instruções que devem ser seguidas para evitar danos no produto ou noutro equipamento.



NOTA indica informações adicionais que são úteis para a utilização ideal e sem problemas do produto.

IMPORTANTE - LEGGERE ATTENTAMENTE LE ISTRUZIONI PRIMA DELL'USO E CONSERVARLE PER FUTURO RIFERIMENTO.

Simboli



AVVERTIMENTO: indica una situazione pericolosa che, se non evitata, potrebbe causare la morte o gravi lesioni.



ATTENZIONE indica una situazione di pericolo che, se non evitata, può provocare lesioni lievi o moderate.



AZIONE OBBLIGATORIA indica istruzioni che devono essere seguite per evitare rischi di lesioni e danni al prodotto o ad altre attrezzature.



AVVISO indica istruzioni da seguire per evitare danni al prodotto o ad altre apparecchiature.



NOTA indica informazioni aggiuntive utili per un utilizzo senza problemi e ottimali del prodotto.

VIKTIGT - LÄS INSTRUKTIONERNA NOGA FÖRE ANVÄNDNING OCH SPARA DEM FÖR FRAMTIDA REFERENS.

Symboler



WARNING! indikerar en potentiellt farlig situation som, om den inte undviks, kan leda till dödsfall eller allvarlig personskada.



FÖRSIKTIGT indikerar en farlig situation som, om den inte undviks, kan leda till mindre eller måttliga skador.



OBLIGATORISK ÅTGÄRD anger instruktioner som måste följas för att undvika risken för skada och skador på produkten eller annan utrustning.



OBSERVERA indikerar instruktioner som måste följas för att undvika skada på produkten eller annan utrustning.



OBS! indikerar ytterligare information som är användbar för problemfri och optimal användning av produkten.

VIGTIGT - LÆS INSTRUKTIONERNE
OMHYGGELEGT FØR BRUG OG GEM
DEM TIL FREMTIDIG REFERENCE.

Symboler



ADVARSEL angiver en potentielt farlig situation, som, hvis den ikke undgås, kan føre til død eller alvorlig skade.



FORSIGTIG angiver en farlig situation, som, hvis den ikke undgås, kan resultere i mindre eller moderat personskaade.



OBLIGATORISK HANDLING angiver instruktioner, der skal følges for at undgå risiko for personskaade og beskaadigelse af produktet eller andet udstyr.



BEMÆRK angiver instruktioner, der skal følges for at undgå skader på produktet eller andet udstyr.



NOTER betyder yderligere information, der er nyttig for problemfri og optimal brug af produktet.

TÄRKEÄÄ - LUE OHJEET
HUOLELLISESTI ENNEN KÄYTTÖÄ
JA SÄILYÄ NE TULEVAA TARVETTA
VARTEN.

Symbolit



VAROITUS viittaa vaaratilanteeseen, joka voi – jos sitä ei vältetä – johtaa kuolemaan tai vakavaan loukkaantumiseen.



VAROITUS ilmaisee vaaratilanteen, joka voi johtaa lievään tai kohtalaiseen loukkaantumiseen, jos sitä ei vältetä.



PAKOLLINEN TOIMINTA ilmaisee ohjeet, joita on noudatettava vammojen ja tuotteen tai muun laitteiston vaurioiden välttämiseksi.



HUOMAUTUS ilmaisee ohjeita, joita on noudatettava tuotteen tai muiden laitteiden vahingoittumisen välttämiseksi.



HUOMAUTUS viittaa lisätietoihin, joista on hyötyä tuotteen ongelmattoman ja optimaalisen käytön kannalta.

VIKTIG - LES INSTRUKSJONENE NØYE
FØR BRUK OG OPPBEVAR DEM FOR
FREMTIDIG REFERANSE.

Symboler



ADVARSEL indikerer en potensielt farlig situasjon som, hvis den ikke unngås, kan føre til død eller alvorlig personskaade.



FORSIKTIG indikerer en farlig situasjon som, hvis den ikke unngås, kan føre til mindre eller moderate personskaader.



OBLIGATORISK HANDLING angir instruksjoner som må følges for å unngå risiko for skade og skade på produktet eller annet utstyr.



MERKNAD angir instruksjoner som må følges for å unngå skade på produktet eller annet utstyr.



MERK indikerer tilleggsinformasjon som er nyttig for problemfri og optimal bruk av produktet.

MIKILVÆGT - LESIÐ
LEIÐBEININGARNAR GAUMGAETILEGA
ÁÐUR EN ÞIÐ NOTIÐ OG GEYMIÐ ÞÆR
FYRIR VÍSUN SÍÐAR.

Táknum



VIÐVÖRUN gefur til kynna hættulegar aðstæður sem geta valdið dauða eða alvarlegum meiðslum ef ekki er í komið í veg fyrir þær.



VARÚÐ gefur til kynna hættulegar aðstæður sem gætu valdið minniháttar eða miðlungsmiklum meiðslum ef ekki er varist.



SKYLDUBOD gefur til kynna leiðbeiningar sem þarf að fylgja til að forðast slysaættu og skemmdir á vörinni eða öðrum búnaði.



TILKYNNING sýnir leiðbeiningar sem þarf að fylgja til að forðast skemmdir á vörinni eða öðrum búnaði.



ATHUGIÐ gefur til kynna viðbótarupplýsingar sem koma að gagni við að tryggja hnökralausa og hagnýta notkun vörunnar.

OLULINE - LUGEGE JUHISED
HOOLIKALT ENNE KASUTAMIST
JA HOIDKE NEED TULEVIKUS
KASUTAMISEKS ALLES.

Sümbolid



HOIATUS tähistab ohtlikku olukorda ja kui seda ei õnnestu vältida, võib see lõppeda surma või kehavigastusega.



ETTEVAATUST tähistab ohtlikku olukorda, mille vältimata jätmise korral võivad tekkida kerged või mõõdukad vigastused.



KOHUSTUSLIK TEGEVUS näitab juhiseid, mida tuleb järgida, et vältida vigastusi ja toote või muu varustuse kahjustamist.



MÄRKUS tähistab juhiseid, mida tuleb järgida, et vältida toote või muude seadmete kahjustamist.



MÄRKUS tähistab lisateavet, mida on vaja toote muretu ja optimaalse kasutamise jaoks.

SVARBU - ATIDŽIAI PERSKAITYKITE
INSTRUKCIJAS PRIEŠ NAUDOJIMĄ IR
IŠSAUGOKITE JAS ATEIČIAI.

Simboliai



Žodžiu **ĮSPĖJIMAS** nurodoma pavojinga situacija, kurios neišvengus galima žūti arba patirti rimtų sužeidimų.



ĮSPĖJIMAS žymi pavojingą situaciją, kurios neišvengus galima patirti lengvą ar vidutinio sunkumo sužalojimą.



PRIVALOMA VEIKSMAI nurodo instrukcijas, kurių reikia laikytis, kad būtų išvengta sužalojimų ir žalos produktui ar kitai įrangai.



ĮSPĖJIMAS nurodo nurodymus, kurių būtina laikytis, kad būtų išvengta gaminio ar kitos įrangos sugadinimo.



Žodžiu **PASTABA** nurodoma papildoma informacija, naudinga norint gaminį eksploatuoti be problemų ir optimaliai naudoti.

SVARĪGI - PIRMS LIETOŠANAS
RŪPĪGI IZLASIET INSTRUKCIJU UN
SAGLABĀJIET TO NĀKOTNEI.

Simboli



BRĪDINĀJUMS norāda uz bīstamu situāciju, kas var izraisīt nāvi vai nopietnu traumu, ja tā netiek novērsta.



UZMANĪBU norāda bīstamu situāciju, kas var izraisīt vieglus vai vidēji smagus ievainojumus, ja no tās netiek novērsta.



OBLIGĀTA DARBĪBA norāda uz instrukcijām, kuras jāievēro, lai izvairītos no savainojumiem un bojājumiem produktam vai citai iekārtai.



NOTICE norāda norādījumus, kas jāievēro, lai izvairītos no produkta vai citu iekārtu bojājumiem.



PIEZĪME sniedz papildinformāciju, kas ir noderīga netraucētai un optimālai produkta lietošanai.

ВАЖЛИВО - УВАЖНО ПРОЧИТАЙТЕ
ІНСТРУКЦІЇ ПЕРЕД ВИКОРИСТАННЯМ
ТА ЗБЕРЕЖІТЬ ЇХ ДЛЯ МАЙБУТНЬОГО
ВИКОРИСТАННЯ.

Символи



ПОПЕРЕДЖЕННЯ вказує на небезпечну ситуацію, яка, якщо її не уникнути, може призвести до смерті або серйозних травм.



УВАГА вказує на небезпечну ситуацію, яка, якщо її не уникнути, може призвести до травм легкого або середнього ступеня тяжкості.



ОБОВ'ЯЗКОВА ДІЯ вказує на інструкції, яких слід дотримуватися, щоб уникнути ризику травмування та пошкодження продукту чи іншого обладнання.



УВАГА вказує на інструкції, яких слід дотримуватися, щоб уникнути пошкодження виробу або іншого обладнання.



ПРИМІТКА вказує на додаткову інформацію, корисну для безперебійного та оптимального використання виробу.

WAŻNE - PRZECZYTAJ UWAŻNIE INSTRUKCJĘ PRZED UŻYCIEM I ZACHOWAJ JĄ NA PRZYSZŁOŚĆ.

Symbole



OSTRZEŻENIE wskazuje potencjalnie niebezpieczną sytuację, która może, jeśli się jej nie uniknie, spowodować poważne obrażenia lub nawet śmierć.



PRZESTROGA wskazuje niebezpieczną sytuację, która, jeśli się jej nie uniknie, może spowodować niewielkie lub umiarkowane obrażenia.



DZIAŁANIE OBOWIĄZKOWE wskazuje instrukcje, które należy przestrzegać, aby uniknąć ryzyka obrażeń i uszkodzenia produktu lub innego sprzętu.



UWAGA oznacza instrukcje, których należy przestrzegać, aby uniknąć uszkodzenia produktu lub innego sprzętu.



UWAGA oznacza dodatkowe informacje, z których warto korzystać, aby bezproblemowo i optymalnie użytkować produkt.

FONTOS - OLVASSA EL FIGYELMESEN AZ UTASÍTÁSOKAT A HASZNÁLAT ELŐTT, ÉS ŐRIZZE MEG AZOKAT A JÖVŐBENI HASZNÁLATRA.

Szimbólumok



FIGYELMEZTETÉS olyan veszélyes helyzetet jelez, amely, ha nem kerülik el, halálhoz vagy súlyos sérüléshez vezethet.



VIGYÁZAT olyan veszélyes helyzetet jelez, amelynek elkerülése esetén kisebb vagy közepesen súlyos sérülések keletkezhetnek.



KÖTELEZŐ TEVÉKENYSÉG azt jelenti, hogy az utasításokat be kell tartani a sérülések és a termék vagy más berendezések károsodásának elkerülése érdekében.



ÉRTESÍTÉS olyan utasításokat jelöl, amelyeket a termék vagy más berendezések károsodásának elkerülése érdekében be kell tartani.



MEGJEGYZÉS a termék problémamentes és optimális használatához hasznos kiegészítő információkat jelöl.

DŮLEŽITÉ - PŘEČTĚTE SI PEČLIVĚ POKYNY PŘED POUŽITÍM A USCHOVEJTE JE PRO BUDOUCÍ POUŽITÍ.

Symbody



VAROVÁNÍ značí nebezpečnou situaci, která může, pokud se jí nevyhnete, vést ke smrti nebo vážnému zranění.



UPOZORNĚNÍ označuje nebezpečnou situaci, která by mohla vést k lehkému nebo středně těžkému zranění.



POVINNÁ AKCE označuje pokyny, které je třeba dodržovat, aby se předešlo riziku zranění a poškození výrobku nebo jiného zařízení.



OZNÁMENÍ označuje pokyny, které je třeba dodržovat, aby nedošlo k poškození výrobku nebo jiného zařízení.



POZNÁMKA značí dodatečné informace, které jsou užitečné pro bezproblémové a optimální používání produktu.

IMPORTANT - CITIȚI CU ATENȚIE INSTRUCȚIUNILE ÎNAINTE DE UTILIZARE ȘI PĂSTRAȚI-LE PENTRU REFERINȚE VIITOARE.

Simboluri



AVERTISMENT indică o situație periculoasă care, dacă nu este evitată, poate provoca răni grave sau deces.



ATENȚIE indică o situație periculoasă care, dacă este evitată, poate duce la răni minore sau moderate.



ACȚIUNE OBLIGATORIE indică instrucțiunile care trebuie urmate pentru a evita riscul de vătămare și deteriorare a produsului sau a altor echipamente.



AVIS Indică instrucțiunile care trebuie urmate pentru a evita deteriorarea produsului sau a altor echipamente.



NOTĂ indică informații suplimentare, care sunt folosite pentru utilizarea fără probleme și optimă a produsului.

DÔLEŽITÉ - PRED POUŽITÍM SI STAROSTLIVO PREČÍTAJTE POKYNY A USCHOVAJTE ICH PRE BUDÚCE POUŽITIE.

Symboly



VAROVANIE označuje nebezpečnú situáciu, ktorá môže mať za následok smrť alebo vážne zranenie, ak sa jej nezabráni.



POZOR označuje nebezpečnú situáciu, ktorá, ak sa jej vyhnete, môže viesť k ľahkému alebo stredne ťažkému zraneniu.



POVINNÁ AKCIA uvádza pokyny, ktoré musia byť dodržané, aby sa predišlo riziku úrazu a poškodeniu výrobku alebo iného zariadenia.



UPOZORNENIE označuje pokyny, ktoré sa musia dodržiavať, aby nedošlo k poškodeniu produktu alebo iného zariadenia.



POZNÁMKA označuje dodatočné informácie, ktoré sú užitočné pre bezproblémové a optimálne používanie výrobku.

ВАЖНО - ПРОЧЕТЕТЕ ВНИМАТЕЛНО ИНСТРУКЦИИТЕ ПРЕДИ УПОТРЕБА И ГИ СЪХРАНЕТЕ ЗА БЪДЕЩА ПРЕПОРАКА.

Символи



ПРЕДУПРЕЖДЕНИЕ показва опасна ситуация, която, ако не бъде избегната, може да доведе до смърт или сериозно нараняване.



ВНИМАНИЕ означава опасна ситуация, която може да доведе до леки или средни наранявания, ако не бъде избегната.



ЗАДЪЛЖИТЕЛНО ДЕЙСТВИЕ указва инструкции, които трябва да се следват, за да се избегне риск от нараняване и повреда на продукта или друго оборудване.



УКАЗАНИЕ посочва инструкции, които трябва да се спазват, за да се предотврати повреда на продукта или друго оборудване.



ЗАБЕЛЕЖКА показва допълнителна информация, която е полезна за безпроблемно и оптимално използване на продукта.

POMEMBNO - PRED UPORABO SKRBNNO PREBERITE NAVODILA IN JIH SHRANITE ZA BODOČO UPORABO.

Simboli



OPOZORILO označuje nevarno situacijo, ki lahko povzroči smrt ali hude poškodbe, če se ji ne izognete.



UPOZORNENIE označuje nebezpečnú situáciu, ktorá by mohla mať za následok ľahké alebo stredne ťažké zranenie, ak sa jej nevyhnete.



OBVEZNA DEJANJA označujejo navodila, ki jih je treba upoštevati, da se prepreči tveganje poškodb in škoda na izdelku ali drugi opremi.



OZNÁMENIE označuje pokyny, ktoré sa musia dodržiavať, aby sa zabránilo poškodeniu výrobku alebo iného zariadenia.



OPOMBA označuje dodatne informacije, ki so koristne za nemoteno in optimalno uporabo izdelka.

VAŽNO - PAŽLJIVO PROČITAJTE UPUTE PRIJE UPOTREBE I SAČUVAJTE IH ZA BUDUĆU UPOTREBU.

Simboli



UPOZORENJE označava opasnu situaciju koja, ako se ne izbjegne, može uzrokovati smrt ili ozbiljnu povredu.



OPREZ označava opasnu situaciju koja može dovesti do manje ili srednje teške ozljede ako se ne izbjegne.



OBAVEZNA RADNJA označava upute koje se moraju slijediti kako bi se izbjegao rizik od ozljeda i oštećenja proizvoda ili druge opreme.



OBAVIJEST označava upute koje morate slijediti kako biste izbjegli oštećenje proizvoda ili druge opreme.



NAPOMENA označava dodatne informacije koje su korisne za neometano i optimalno korištenje proizvoda.

ΣΗΜΑΝΤΙΚΟ - ΔΙΑΒΑΣΤΕ
ΠΡΟΣΕΚΤΙΚΑ ΤΙΣ ΟΔΗΓΙΕΣ ΠΡΙΝ
ΤΗ ΧΡΗΣΗ ΚΑΙ ΚΡΑΤΗΣΤΕ ΤΙΣ ΓΙΑ
ΜΕΛΛΟΝΤΙΚΗ ΑΝΑΦΟΡΑ.

Σύμβολα



ΠΡΟΕΙΔΟΠΟΙΗΣΗ υποδεικνύει επικίνδυνη κατάσταση η οποία, εάν δεν αποφευχθεί, ενδέχεται να καταλήξει σε θάνατο ή επικίνδυνο τραυματισμό.



ΠΡΟΣΟΧΗ υποδεικνύει μια επικίνδυνη κατάσταση η οποία, εάν δεν αποφευχθεί, θα μπορούσε να οδηγήσει σε μικρό ή μέτριο τραυματισμό.



ΥΠΟΧΡΕΩΤΙΚΗ ΕΝΕΡΓΕΙΑ υποδεικνύει οδηγίες που πρέπει να ακολουθούνται για να αποφευχθεί ο κίνδυνος τραυματισμού και ζημιών στο προϊόν ή σε άλλο εξοπλισμό.



ΕΙΔΟΠΟΙΗΣΗ υποδεικνύει οδηγίες που πρέπει να ακολουθούνται για την αποφυγή ζημιών στο προϊόν ή σε άλλο εξοπλισμό.



ΣΗΜΕΙΩΣΗ υποδεικνύει επιπλέον πληροφορίες οι οποίες είναι χρήσιμες για την απρόσκοπτη και βέλτιστη χρήση του προϊόντος.

IMPORTANTI - AQRA
L-ISTRUZZJONIJIET BIR-REQQAQ
QABEL L-UŻU U ŻOMM GĦAL
REFERENZA FUTURA.

Simboli



TWISSIJA tirraguna situazzjoni perikoluża li, jekk mhix tintlahaq, tista' twassal għall-mewt jew l-inguurja serja.



ATTENZJONI tittratta situazzjoni perikoluża li, jekk mhix tintlahaq, tista' twassal għall-inguurja zghira jew modera.



AZZJONI MANDATORJA tindika istruzzjonijiet li jridu jiġu segwiti biex jiġu evitati riskji ta' korrimment, u hsara lill-prodott jew tagħmir iehor.



NOTTA tinnota l-istruzzjonijiet li għandhom jiġu segwiti biex jinftiehu d-danni lill-prodott jew għal ikkawża għal-iehor.



NOTA tindika informazzjoni addizzjonali li hija utli biex tagħmel l-ahjar użu, bla problemi, tal-prodott.

ÖNEMLI - KULLANMADAN ÖNCE
TALIMATLARI DİKKATLICE OKUYUN
VE GELECEKTE BAŞVURMAK ÜZERE
SAKLAYIN.

Semboller



UYARI, kaçınılmadığı takdirde ölüm veya ciddi yaralanmayla sonuçlanabilecek tehlikeli bir durumu belirtir.



DİKKAT önlenmediği takdirde küçük veya orta dereceli yaralanmayla sonuçlanabilecek tehlikeli bir durumu belirtir.



ZORUNLU EYLEM, yaralanma ve ürün veya diğer ekipman hasarını önlemek için takip edilmesi gereken talimatları belirtir.



DUYURU, ürüne veya diğer ekipmanlara zarar vermektan kaçınmak için izlenmesi gereken talimatları belirtir.



NOT, ürünün sorunsuz ve en iyi şekilde kullanımı için yararlı ek bilgileri belirtir.

重要 - 使用前仔细阅读说明, 并妥善保存
以备将来参考。

符号



警告表示危险情况, 如果不避免,
可能会导致死亡或严重伤害。



注意 表示危险情况, 如果不避免,
可能会导致轻微或中度伤害。



强制行动表示必须遵循的指示,
以避免受伤以及产品或其他设备的损坏。



注意 表示必须遵守的说明, 以避免
损坏产品或其他设备。



注意表示有助于无故障和最佳使用
产品的附加信息。

重要 - 使用前仔細閱讀說明，並妥善保存以備將來參考。

符號



警告表示危險情況，如果不避免，可能會導致死亡或嚴重傷害。



注意 表示危險情況，如果不避免，可能會導致輕微或中度傷害。



強制行動表示必須遵循的指示，以避免受傷以及產品或其他設備的損壞。



注意 表示必須遵守的說明，以避免損壞產品或其他設備。



注意表示有助於無故障和最佳使用產品的附加信息。

중요 - 사용 전에 설명서를 주의 깊게 읽고 나중에 참고할 수 있도록 보관하십시오.

기호



경고는 피하지 않을 경우 사망이나 심각한 부상을 초래할 수 있는 위험한 상황을 나타냅니다.



주의 피하지 않을 경우 경상 또는 증상을 입을 수 있는 위험한 상황을 나타냅니다.



필수 조치는 부상 및 제품 또는 다른 장비에 대한 손상을 방지하기 위해 따라야 하는 지침을 나타냅니다.



알림 제품 또는 기타 장비의 손상을 방지하기 위해 따라야 하는 지침을 나타냅니다.



참고는 제품을 문제 없이 최적으로 사용하는 데 유용한 추가 정보를 나타냅니다.

JA

重要 - 使用前に注意して説明書をお読みいただき、今後の参考のために保管してください。

記号



警告は、回避しないと死亡または重傷を負う可能性がある危険な状況を示します。



注意 回避しない場合、軽度または中程度の傷害を引き起こす可能性がある危険な状況を示します。



必須の行動は、怪我や製品や他の機器の損傷を避けるために従うべき指示を示します。



注 製品または他の機器への損傷を避けるために必ず従わなければならない指示を示します。



注は、製品をトラブルなく最適に使用するために役立つ追加情報を示します。

MS

PENTING - BACA ARAHAN DENGAN TELITI SEBELUM DIGUNAKAN DAN SIMPAN UNTUK RUJUKAN MASA DEPAN.

Symbol



AMARAN menunjukkan keadaan berbahaya yang, jika tidak dielakkan, boleh mengakibatkan kematian atau kecederaan serius.



AWAS menunjukkan situasi berbahaya yang, jika tidak dielakkan, boleh mengakibatkan kecederaan ringan atau sederhana.



TINDAKAN WAJIB menunjukkan arahan yang mesti diikuti untuk mengelakkan risiko kecederaan dan kerosakan kepada produk atau peralatan lain.



NOTIS menunjukkan arahan yang mesti diikuti untuk mengelakkan kerosakan pada produk atau peralatan lain.



NOTA menunjukkan maklumat tambahan yang berguna untuk penggunaan produk yang bebas masalah dan optimum.

สำคัญ - อ่านคำแนะนำอย่างละเอียดก่อนใช้งานและเก็บไว้สำหรับอ้างอิงในอนาคต

สัญลักษณ์



คำเตือน บ่งชี้ถึงสถานการณ์อันตรายซึ่งหากไม่หลีกเลี่ยง อาจส่งผลให้เสียชีวิตหรือบาดเจ็บสาหัสได้



ข้อควรระวัง บ่งชี้ถึงสถานการณ์ที่เป็นอันตรายซึ่งหากไม่หลีกเลี่ยง อาจส่งผลให้เกิดการบาดเจ็บเล็กน้อยหรือปานกลาง



การกระทำที่จำเป็น บ่งชี้คำแนะนำที่ต้องปฏิบัติตามเพื่อหลีกเลี่ยงความเสี่ยงต่อการบาดเจ็บและความเสียหายต่อผลิตภัณฑ์หรืออุปกรณ์อื่นๆ



ข้อสังเกต ระบุคำแนะนำที่ต้องปฏิบัติตามเพื่อหลีกเลี่ยงความเสียหายต่อผลิตภัณฑ์หรืออุปกรณ์อื่นๆ



หมายเหตุ ระบุข้อมูลเพิ่มเติมที่เป็นประโยชน์สำหรับการใช้ผลิตภัณฑ์อย่างปลอดภัยและเหมาะสมที่สุด

קרא - קרא בזהירות את האורחות לשימוש ושמור אותן לעיון בעתיד.

מילים



אזהרה מציינת מצב מסוכן שאם לא נמנע ממנו עלול לגרום למוות או לפציעה חמורה



אזהרה מציינת מצב מסוכן שאם לא נמנע, עשוי להוביל לפגיעה קלה או בינונית.



פעולה חובה מצביעה על הנחיות שיש לעקוב אחריהן כדי להימנע מסיכון לפציעה ונזק למוצר או לציוד אחר.



שים לב מציינת הנחיות שחייבות להיות נעקבות כדי למנוע נזק למוצר או לציוד אחר.



הערה מציינת מידע נוסף המועיל לשימוש אופטימלי וללא תקלות של המוצר.

AR

مهم - اقرأ التعليمات بعناية قبل الاستخدام واحفظها للرجوع إليها في المستقبل.

رموز



تحذير يشير إلى موقف خطير قد يؤدي، عند عدم تجنبه، إلى الموت أو حدوث إصابة خطيرة.



تحذير يشير إلى موقف خطير قد يؤدي، عند عدم تجنبه، إلى الموت أو حدوث إصابة خطيرة.



يشير إجراء إلزامي إلى التعليمات التي يجب اتباعها لتجنب خطر الإصابة أو تلف المنتج أو المعدات الأخرى.



يشير الإشعار إلى الإرشادات التي يجب اتباعها لتجنب تلف المنتج أو المعدات الأخرى.



ملاحظة تشير إلى معلومات إضافية مفيدة من أجل استخدام مثالي للمنتج خالي من المشاكل.

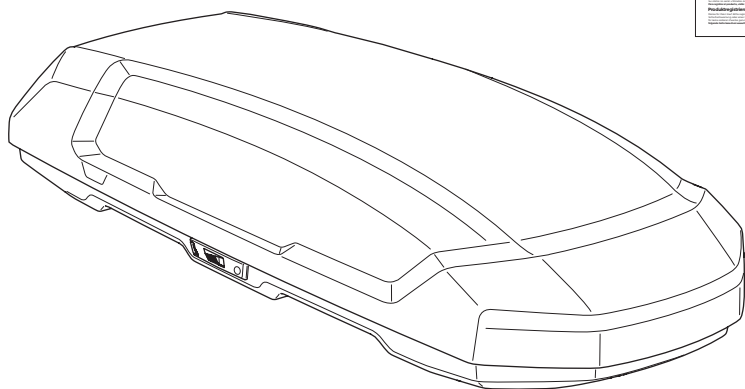
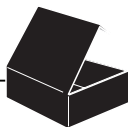

x1

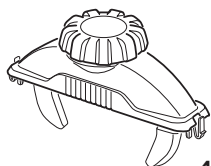

x4

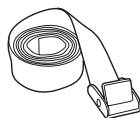

x3

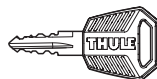

x2

i

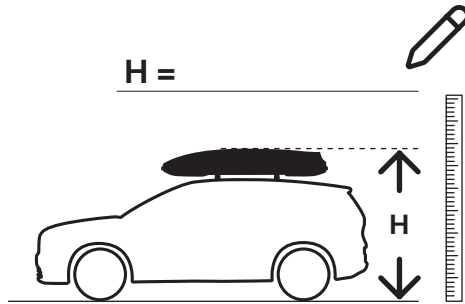

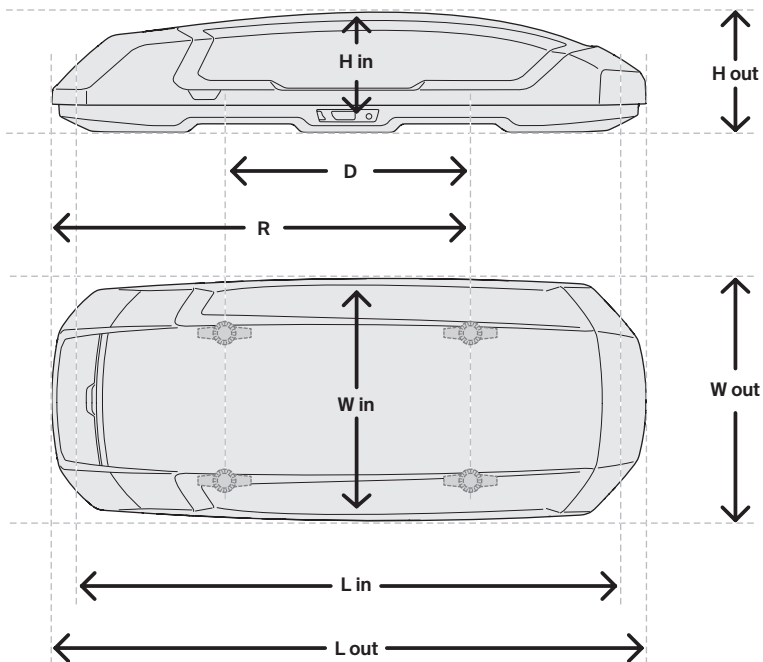
i

		D Min	D Max	L out	W out	H Out	R Min	L in	W in	H in
S	mm	541	828	1399	897	379	973	1314	783	350
M	mm	555	930	1753	812	443	1149	1671	694	384
XXL Sport	mm	555	930	2321	699	440	1431	2239	582	379
L Sport	mm	555	930	1910	627	423	1265	1828	512	365
L	mm	555	930	1951	845	425	1285	1869	727	366
XL	mm	555	930	2153	868	470	1347	2071	749	373



Max 75 kg

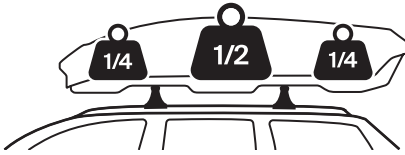

	Weight	Volume
S	14.8 kg	324 litre
M	16.8 kg	408 litre
L	19.2 kg	445 litre
L Sport	15.4 kg	312 litre
XXL Sport	18.7 kg	472 litre
XL	21.5 kg	515 litre

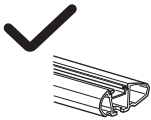

Thule WingBar Evo

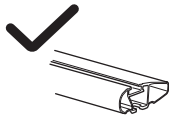

Thule WingBar

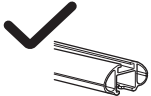

Thule AeroBar



Thule Squarebar

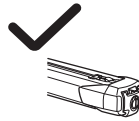

Thule SlideBar

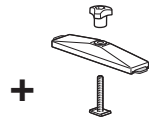

Thule T-track Adapter

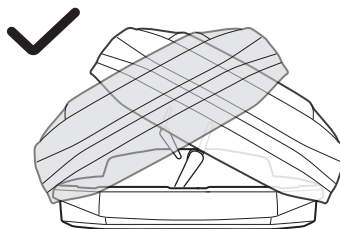
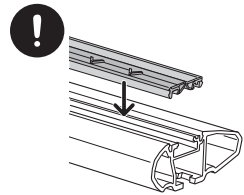
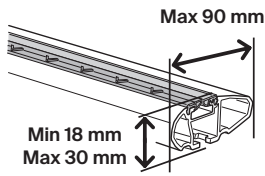
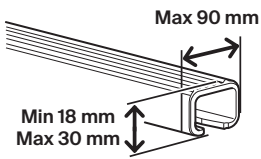

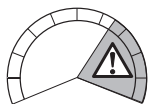

Max
130 km/h

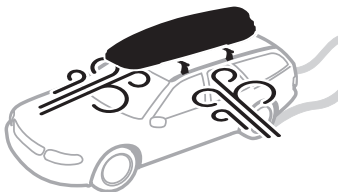
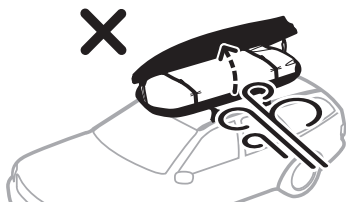
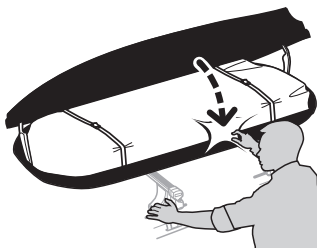
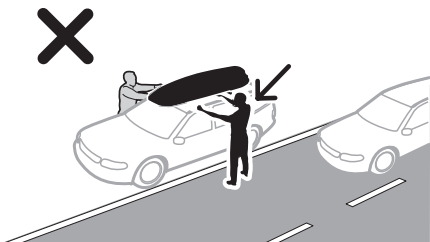
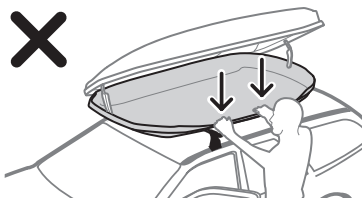
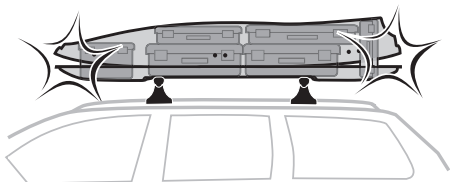
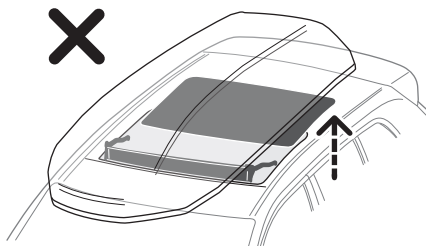

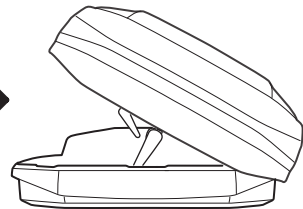
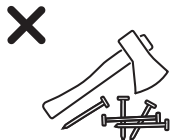
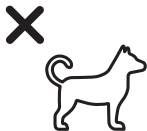
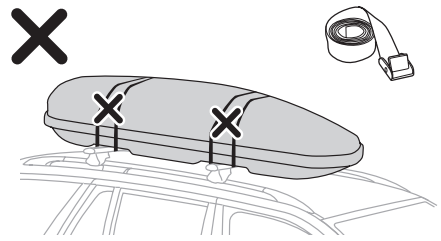
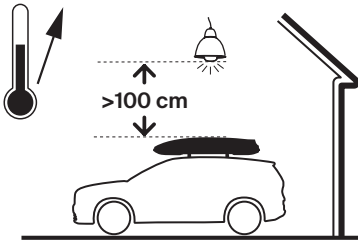
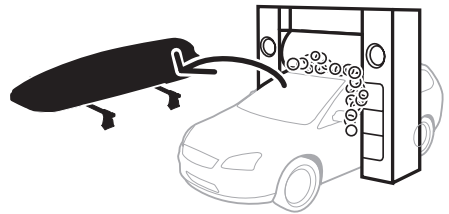
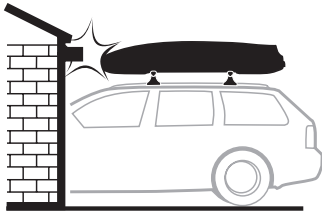
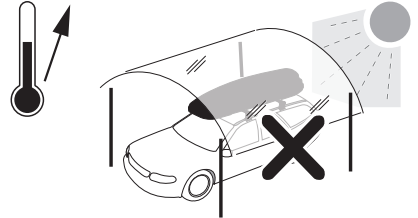
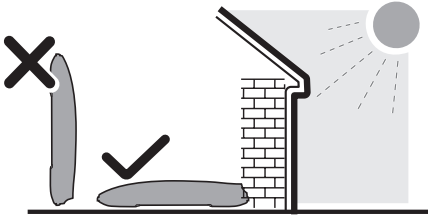

1

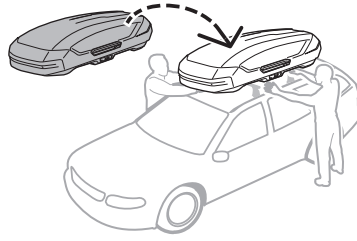
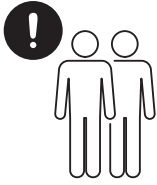

2

A

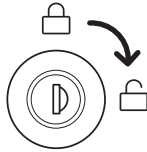

B

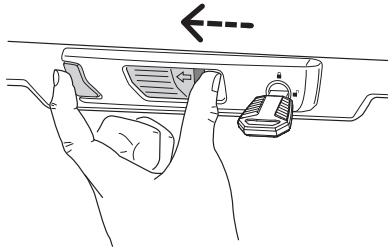

C

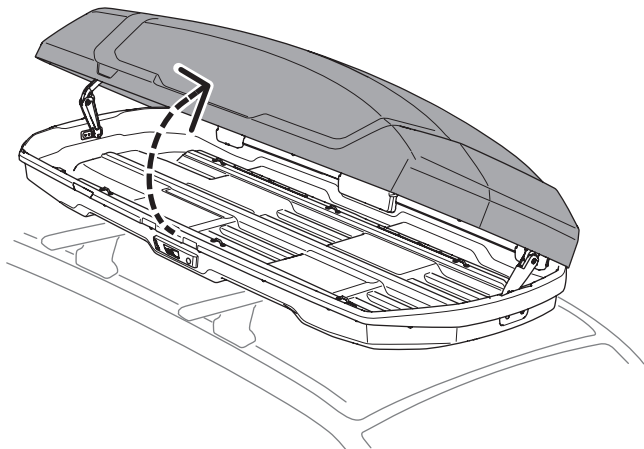

3

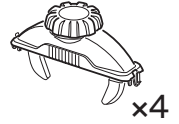

A

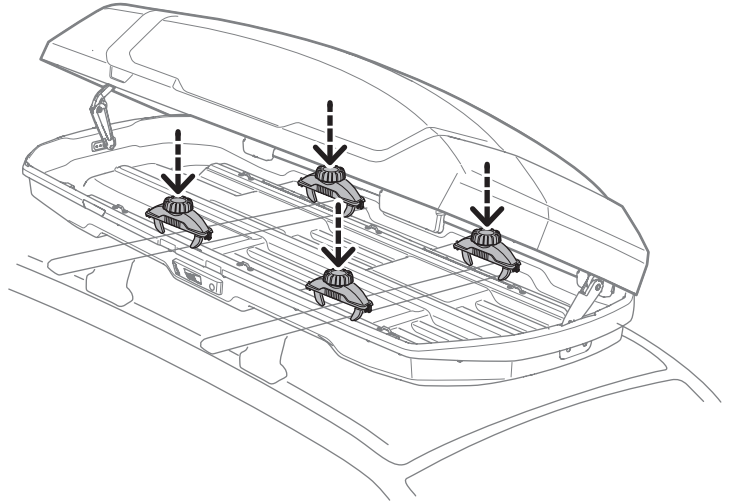
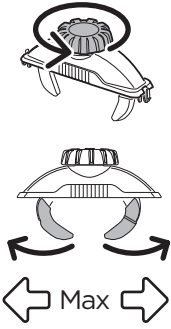

B

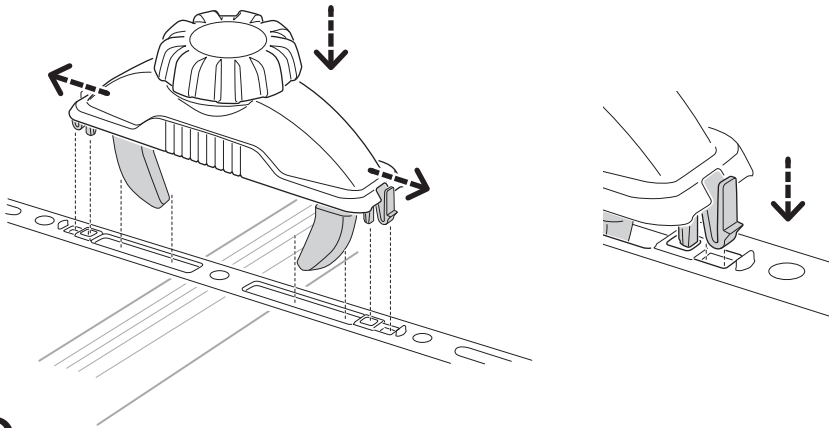

C

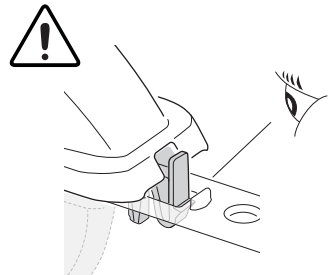
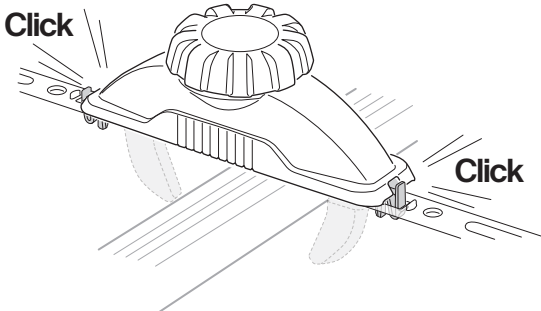

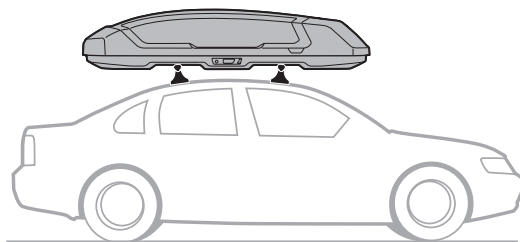
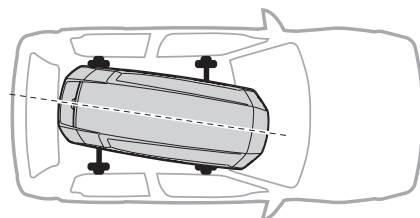
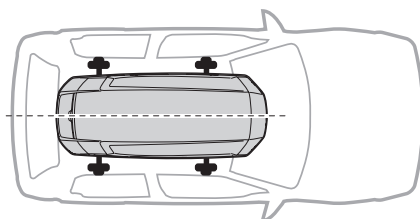
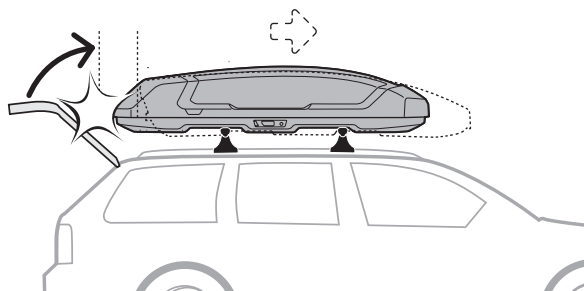

4

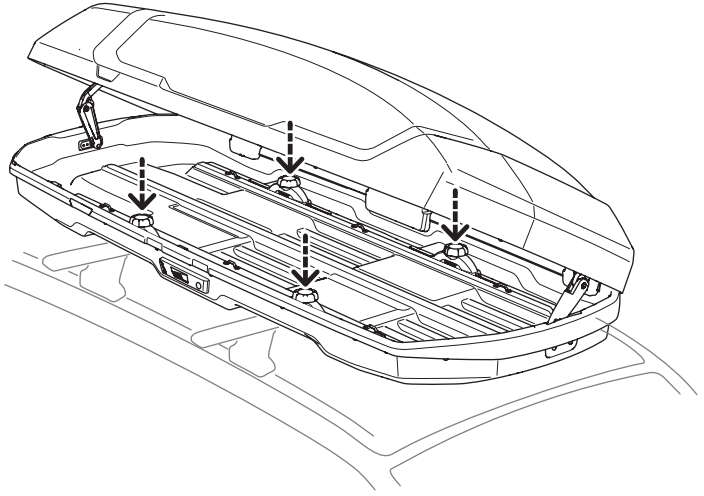

Click
Click
Click

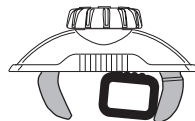
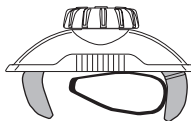
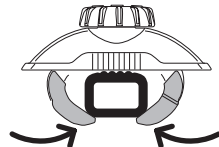
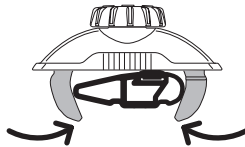
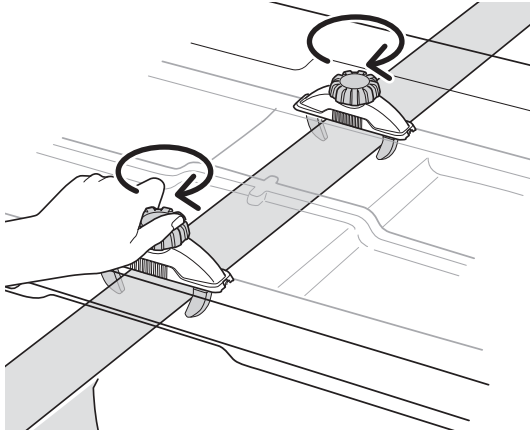

5

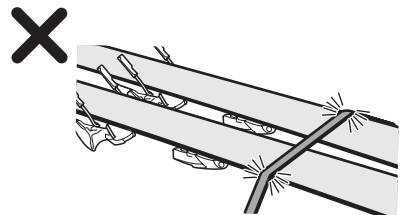
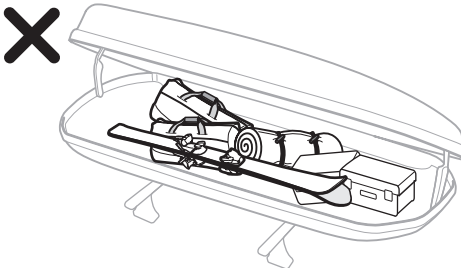
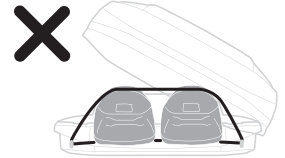
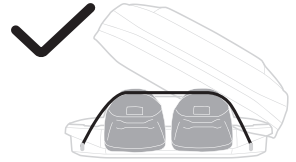
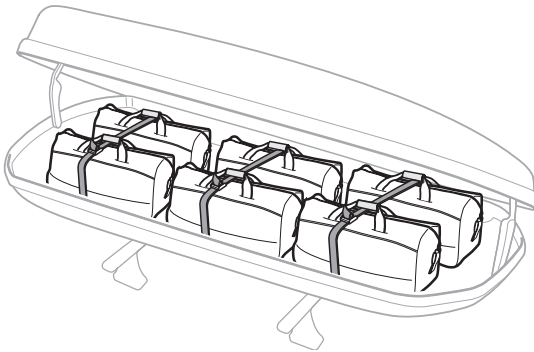
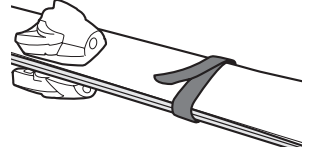
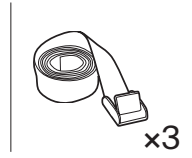
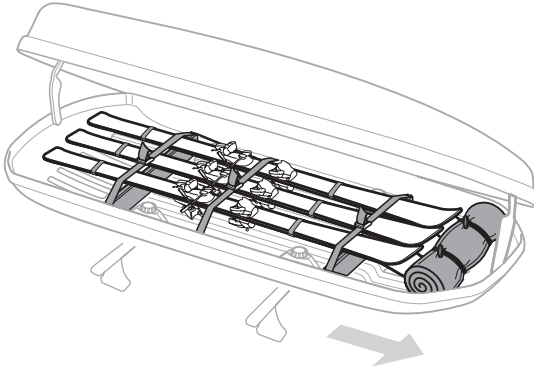

6

A

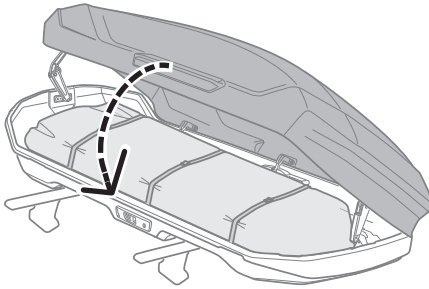

B

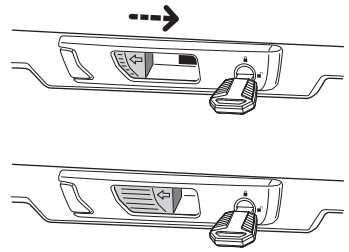
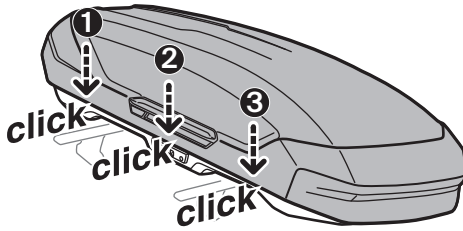

C

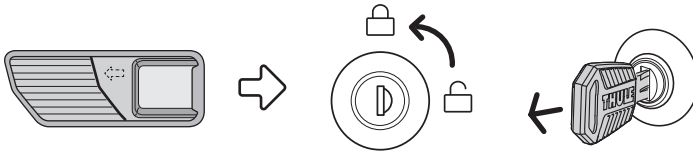



Thule.com

EN Accessories/Spare parts
FR Accessoires/Pièces de rechange
ES Accesorios/Repuestos
DE Zubehör/Ersatzteile
NL Accessoires/Onderdelen
PT Acessórios/Peças de reposição
IT Accessori/Pezzi di ricambio
SV Tillbehör/Reservdelar
DA Tilbehør/Reservedeler
NO Tilbehør/Reservedeler
FI Lisävarusteet/Varaosat
IS Aukabúnaður/Varahlutir
ET Tarvikud/Varuosad
LV Piederumi/Rezerves daļas
LT Priedai/Atsarginės dalys
UK Аксесуари/Запасні частини
PL Akcesoria/Części zamienne

CS Příslušenství/Náhradní díly
HU Kiegészítők/Alkatrészek
RO Accesorii/Piese de schimb
SK Príslušenstvo/Náhradné diely
SL Dodatki/Nadomestni deli
BG Аксесоари/Резервни части
HR Dodaci/Rezervni dijelovi
EL Αξεσουάρ/Ανταλλακτικά
TR Aksesuarlar/Yedek parçalar
MT Accessorji/Partijiet tal-bdil
ZH-SC 附件/备件
ZH-TR 配件/備件
JA アクセサリー/予備部品
KO 액세서리/예비 부품
TH อุปกรณ์เสริม/อะไหล่
MS Aksesori/Alat ganti

الملحقات / قطع غيار **AR**

אביזרים / חלקי תיקון **HE**

Thule Sweden AB

Borggatan 5, 335 73 Hillerstorp, Sweden
info@thule.com | www.thule.com

©Thule. All rights reserved.
5565337001 | 2026-04-10 #02